

# AM-FM MULTIPLEX ALIGNMENT



## AM ALIGNMENT

Step	Adjusting circuit	Connection		SG. frequency	Position of tuning dial	Adjustment	V.T.V.M. Oscilloscope
		Input	Output				
1	IF	Connect sweep generator to VC4.	Connect oscilloscope to test point Pin No. 8	455 KHz	Near max. capacity of VC at position with no signal.	AM 1st 9-21310 AM DET 9-21291	 455 KHz
2	RF	Connect standard loop antenna to output terminal of SG. Place receiver 2 feet from loop antenna	Connect V.T.V.M. to Pin No. 8	600 KHz (400Hz, 30 % modulation)	600 KHz	AM ANT 9-25040 AM OSC 9-20880	Max.
3				1400 KHz (400Hz, 30 % modulation)	1400 KHz	TC 5 TC 6	Max.
4	Repeat adjustments.						

1. Variable capacitor completely closed.
2. Set the dial pointer to very left line dial scale.
3. Connect sweep generator, SG, V.T.V.M. and oscilloscope.

4. Function switch to "AM."
5. Use a screwdriver with plastic grip for all adjustments.

## FM ALIGNMENT

Step	Adjusting circuit	Connection		SG.frequency	Position of tuning dial	Adjustment	V.T.V.M. Oscilloscope
		Input	Output				
1	IF	Connect sweep generator to test point VC3 through 0.01 $\mu$ F.	Connect oscilloscope to test point TP 7 IC 02 Pin No. 13	10.7 MHz (none modulation)	Near max. capacity of VC. at position with no signal.	IFT In FRONT END	 10.7MHz
2	Ratio Det.		Connect oscilloscope to test point TP 1			FM QUADRA TURE COIL. 9-21320	
3	RF	Connect FM SG. to FM ANT terminals.	Connect V.T.V.M. to speaker terminal.	90 MHz (400 Hz, 30 % modulation)	90 MHz	LA LR	Max.
4				106 MHz (400 Hz, 30 % modulation)	106 MHz	TCA TCR	Max.
5	Repeat adjustments.						

1. Variable capacitor completely closed.
2. Set the dial pointer to very left line of dial scale.
3. Connect sweep generator, FM SG, V.T.V.M. and oscilloscope. FM ANT input impedance is 300 ohm.

4. Function switch to "FM."
5. Use a screwdriver with plastic grip for all adjustments.

## FM MPX ALIGNMENT

Step	Adjusting circuit	Connection		Position of tuning dial	Adjustment	
		Input	Output			
1	PLL IC FO (19 KHz) Adjustment	None	Connect Frequency counter or synchroscope to TP 2		Adjust VR 03(4.7K-B) so that 19 KHz may be indicated on the frequency counter or synchroscope.	
2	FM STEREO Signal Separation	Connect FM stereo SG to FM ANT terminals. 19 KHz signal ON. Main channel, sub channel signal ON. Add 1000 Hz signal from L Ch.	Connect V.T.V.M. to output terminal (R channel).	Near max. capacity of VC. at position with no signal.	VR 02 (1K-B)	V.T.V.M. Min.
		Connect FM stereo SG to FM ANT terminals. 19 KHz signal ON. Main channel, sub channel signal ON. Add 1000 Hz signal from R Ch.	Connect V.T.V.M. to output terminal (L channel)			
3	Repeat steps 1, 2, Set at position with max. channel separation.					

1. Variable capacitor completely closed.
2. Connect FM stereo SG and V.T.V.M.

3. Function switch to "FM"
4. Use a screwdriver with plastic grip for all adjustments.

# AM-FM RF/IF MPX BOARD LAYOUT

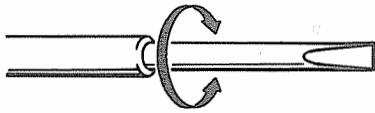

## FRONT END

9-20390

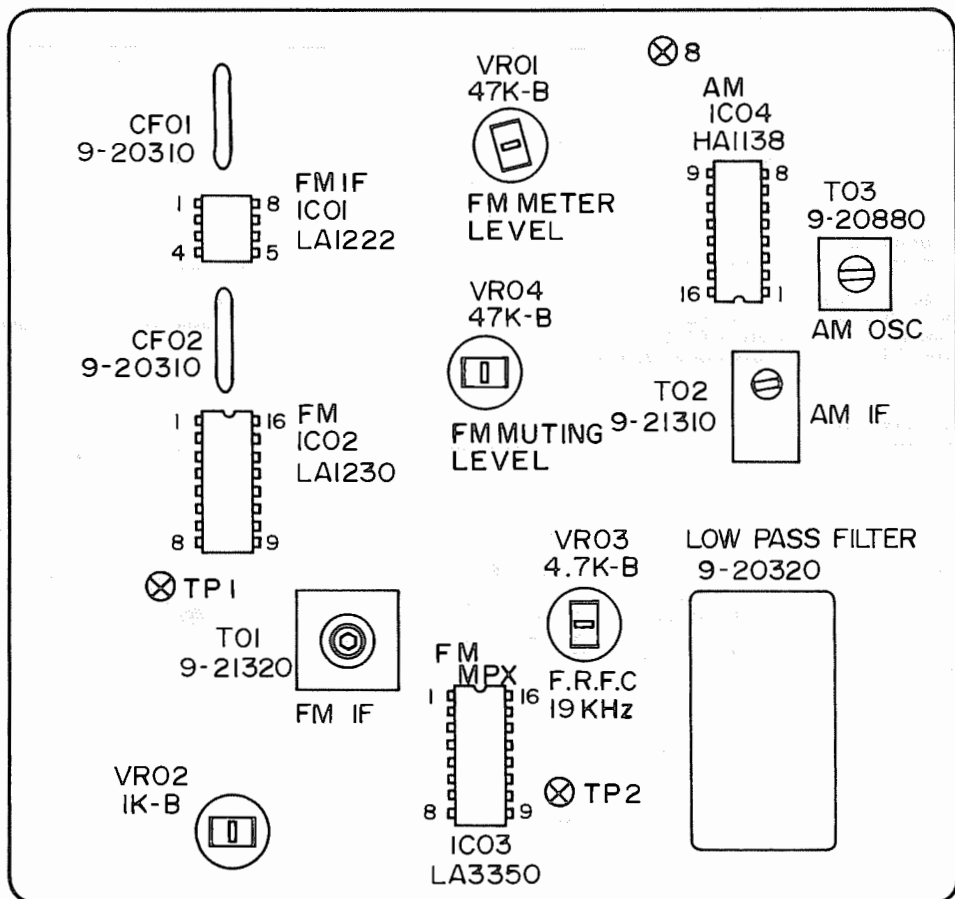
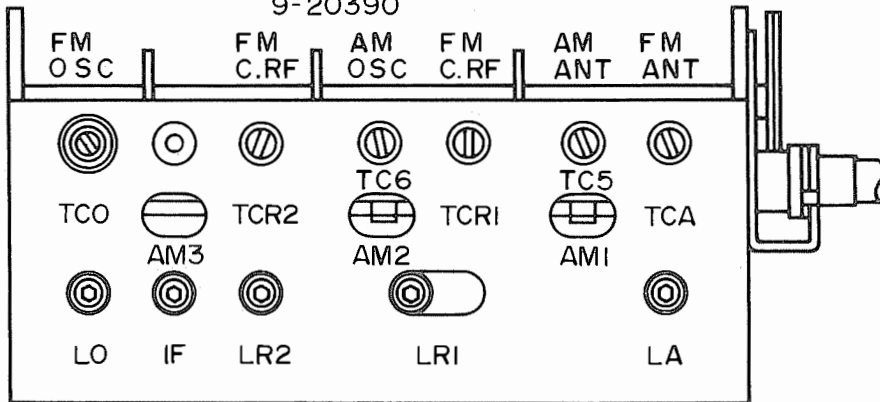

## ADJUSTMENT OF THE POWER AMP. P.C. BOARD

### BEFORE ADJUSTMENT

1. Disconnect the PRE OUT/MAIN IN connector.
2. After the power switch is turned ON, allow a few minutes marking adjustment, to be sure of the most stable operation.
3. Connect dummy load resistors (8 ohm) to the speaker terminals.
4. Use DC V.T.V.M. or Circuit Tester (input impedance: More than 50k ohm/V)

### (A) IDLING CURRENT ADJUSTMENT

Adjust VR01 (VR02) for an idling current of 30mA, Measure the voltage at both sides of R65 (R66) resistor (0.47 ohm) and Adjust VR01 (VR02) to indicate  $14mV \pm 2mV$ .

Note: Polarity of Emitter of Q01 (Q02) is (+) Mid-Point is (-).

- a. Turn the semi-fixed variable resistor slowly during adjustment.
- b. Be careful of the polarity of each measurement point.

## DIAL CORD STRINGING

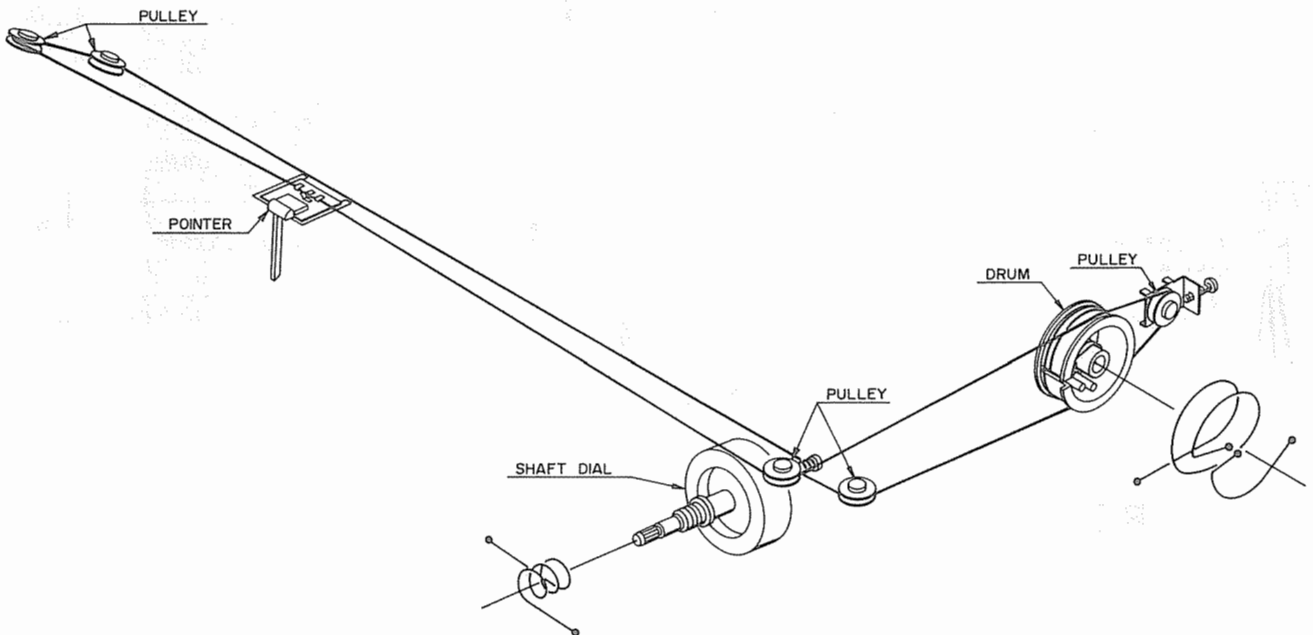

# AM-FM RF/IF MPX P.C.BOARD

## IC TOP VIEW

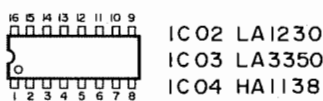
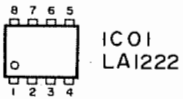

## DIODE FRONT VIEW



DO1~DO7  
DS-442

IF IN  
FRONT END PIN NO.3  
FRONT END PIN NO.2

FRONT END +B 12.4V  
FRONT END PIN NO.8 AGC

SIGNAL STRENGTH (+)

POWER SUPPLY P.C.B PIN NO.3+B 12.4V

AM OUT

AM SIGNAL STRENGTH (+)

## TRANSISTOR FRONT VIEW



Q01, Q03-Q05  
•2SC 536  
Q02  
•2SA 659

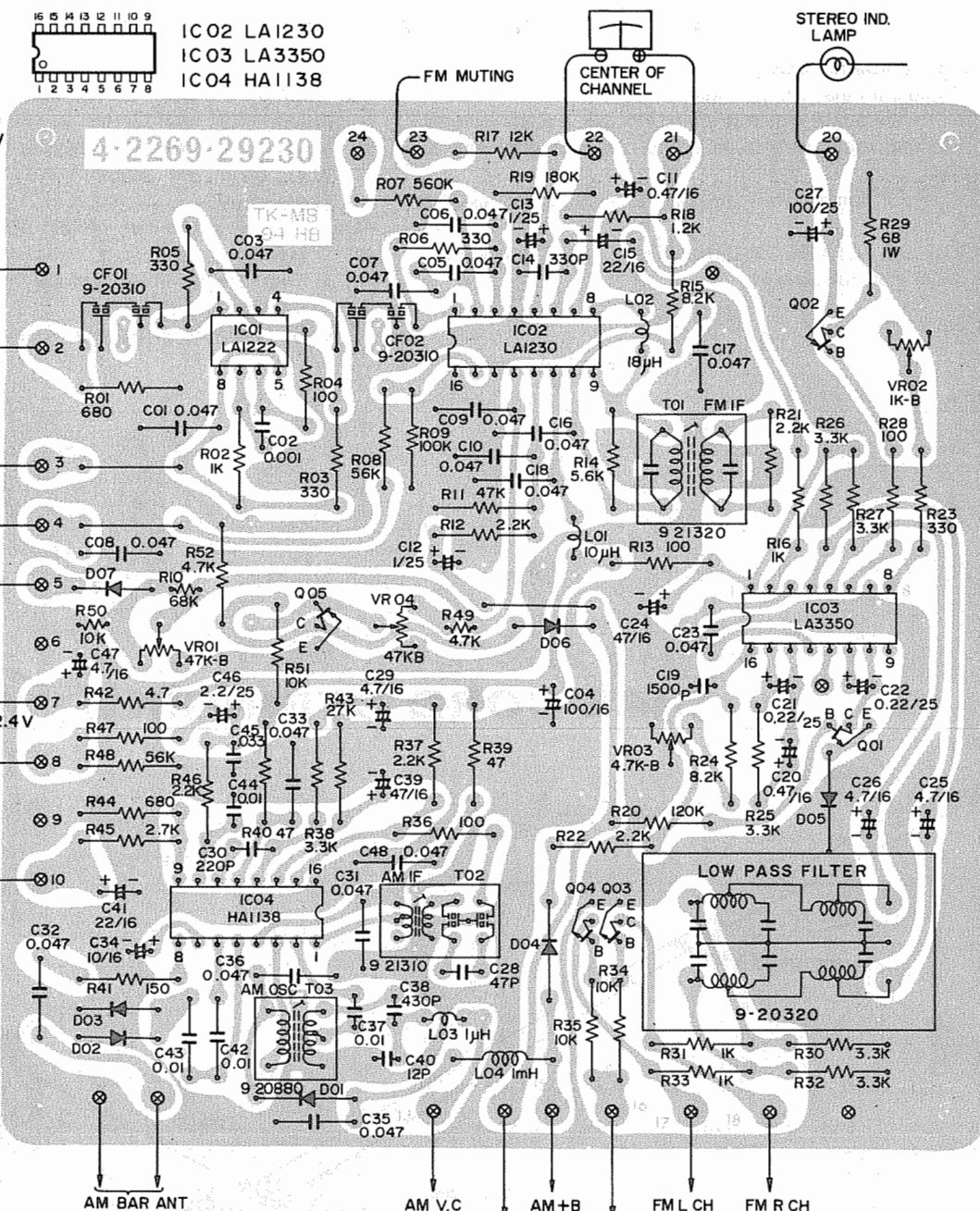

## BOTTOM VIEW

AM BAR ANT

AM V.C (OSC)  
MUTING PRE P.C.B PIN NO.6 AND NO.5  
MUTING  
FM L CH OUTPUT  
FM R CH

	PIN NUMBERS VOLTAGES															
	1	2	3	4	5	6	7	8	9	10	11	12	13	14	15	16
IC01 LA1222	1.39V	1.39V		11.5V	12.4V	1.35V	9.7V	12.4V								
IC02 LA1230	2.85V	2.85V	2.85V	0V	0V	5.92V	5.73V	5.75V	5.75V	5.75V	12.1V	3.38V	0.54V	0V	5.13V	0V
IC03 LA3350	10.7V	2.74V	4.71V	8.08V	8.11V	11.6V	0V	0.34V		0.56V	2.08V	2.25V	1.96V	2.09V	2.08V	2.85V
IC04 HA1138	11.7V	2.79V	11.7V	11.7V	4.9V	9.86V	2.0V	0.88V	0.06V	3.8V	4.3V	11.8V	2.76V	2.77V	2.72V	0V

# tone control and mode sel

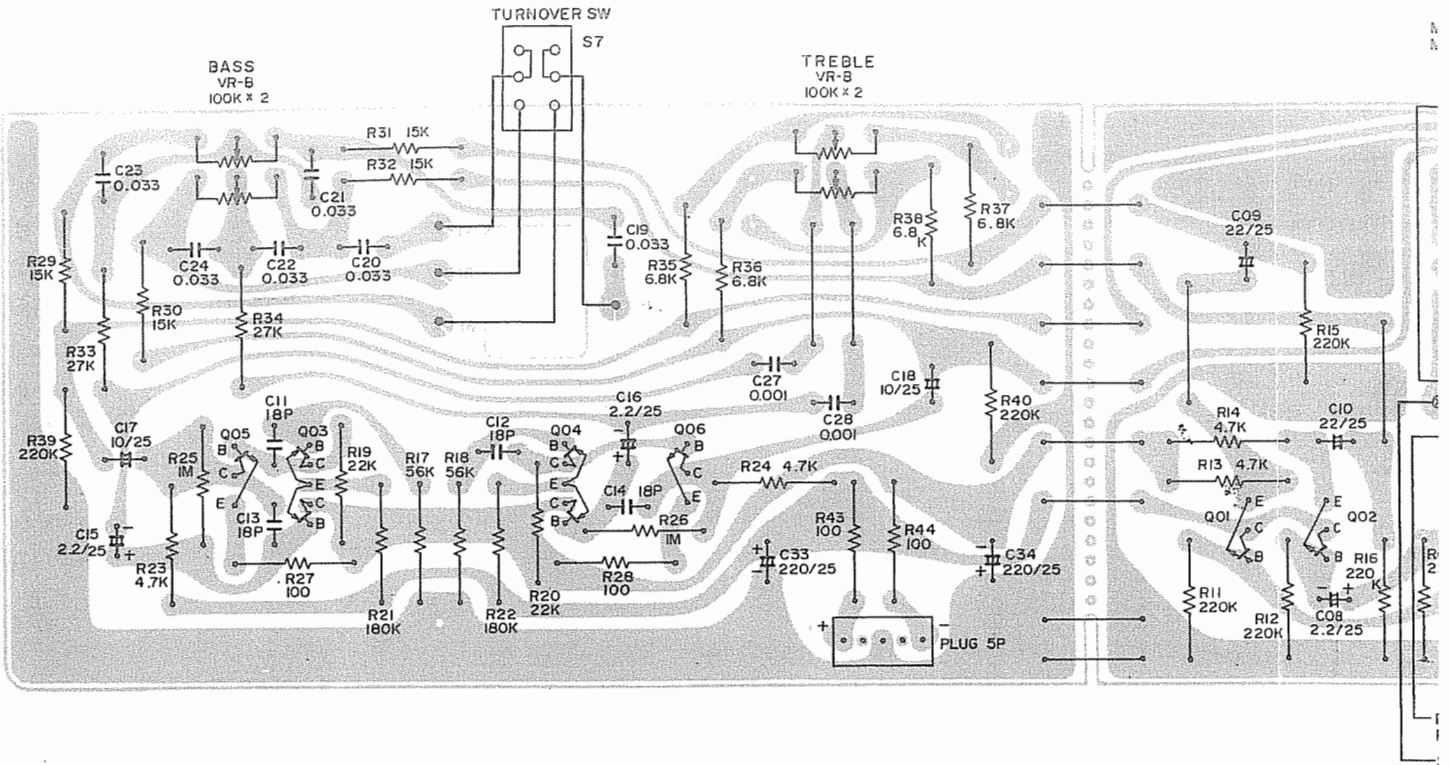

RS-1050

# tone control and mode se

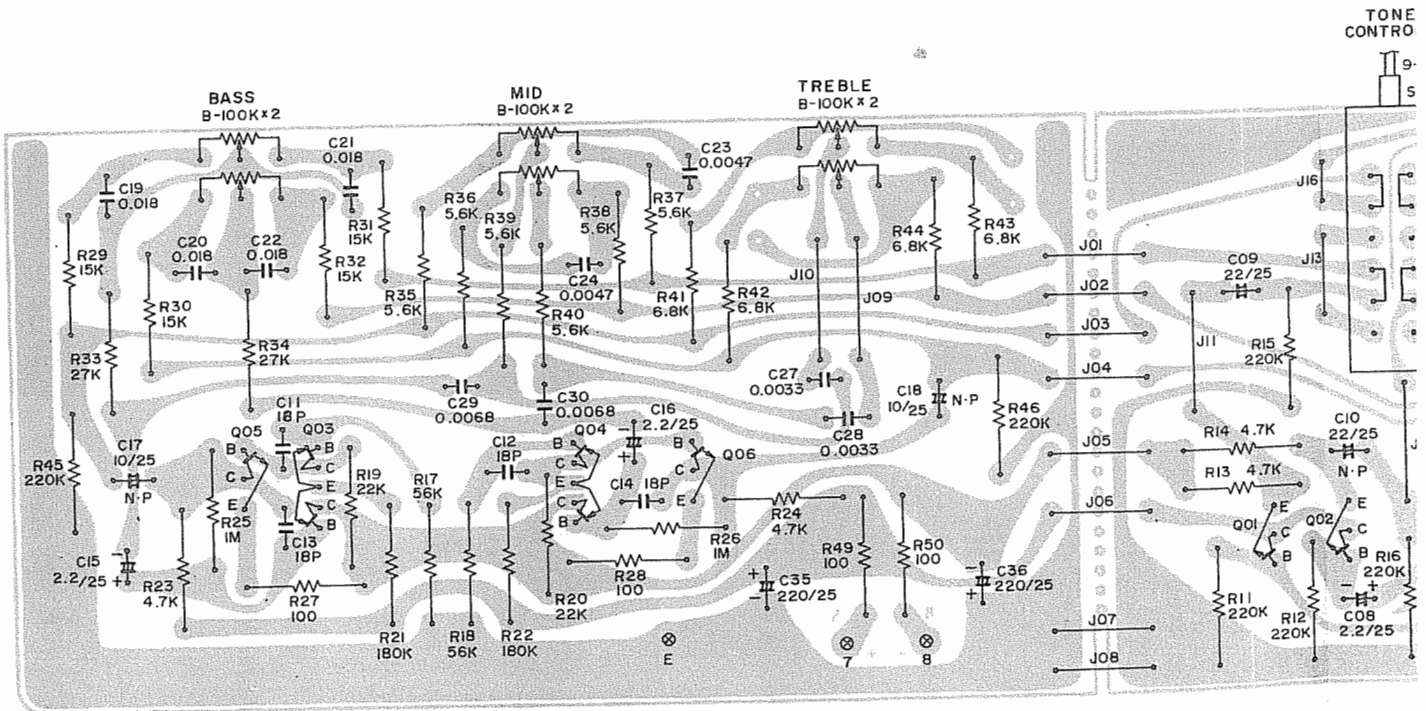

# SELECTOR P.C. BOARD

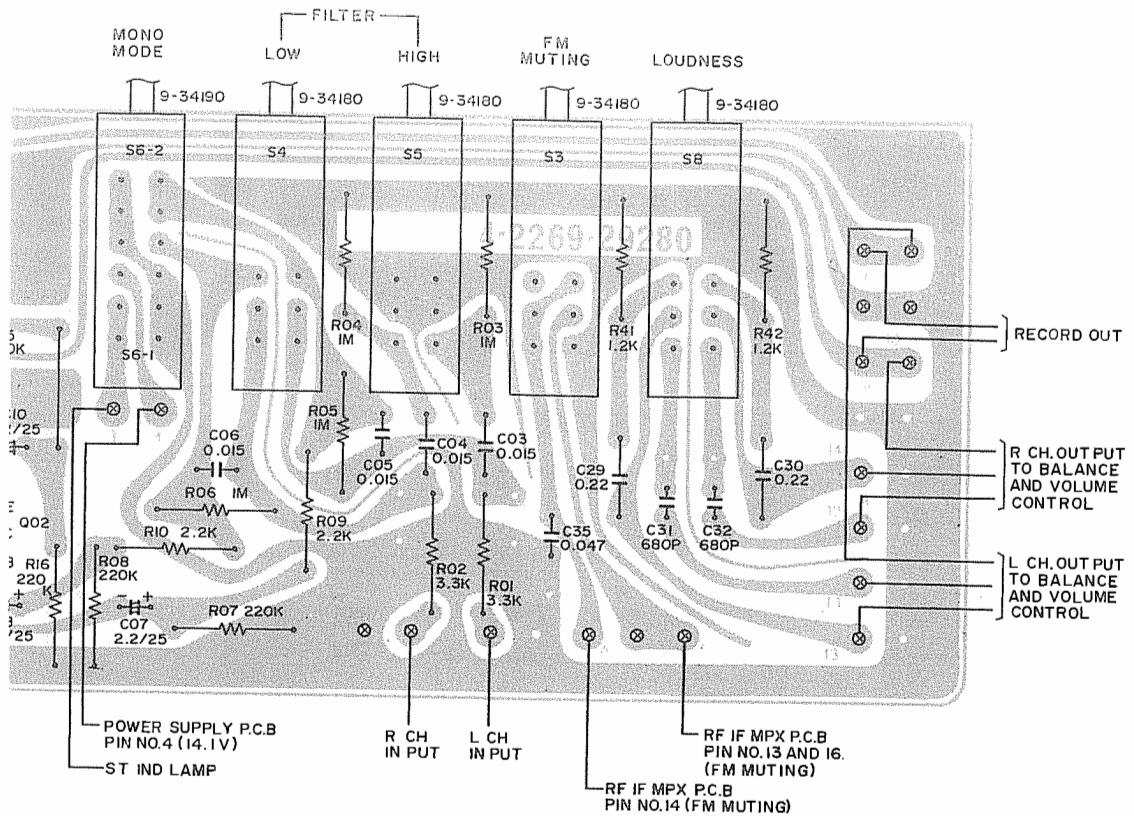

# SELECTOR P.C. BOARD

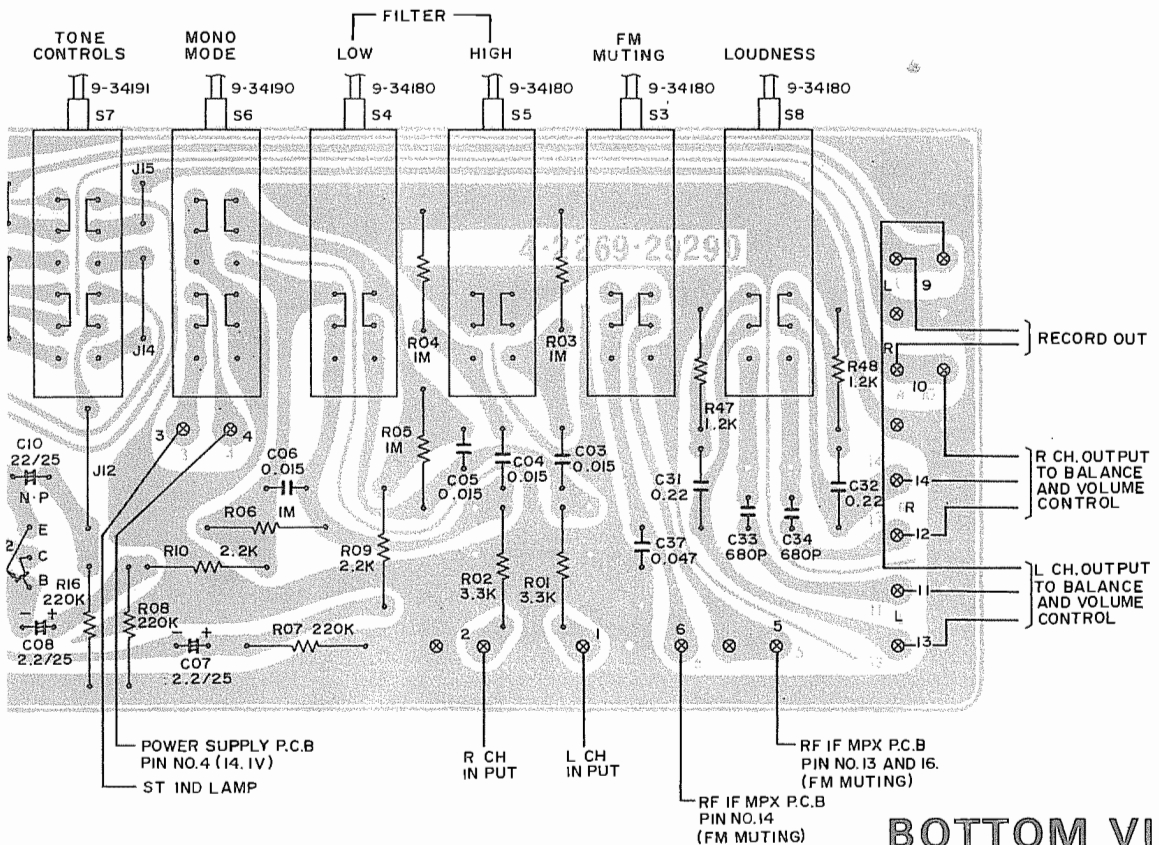

**BOTTOM VIEW**



POWER SUPPLY P.C.BOARD

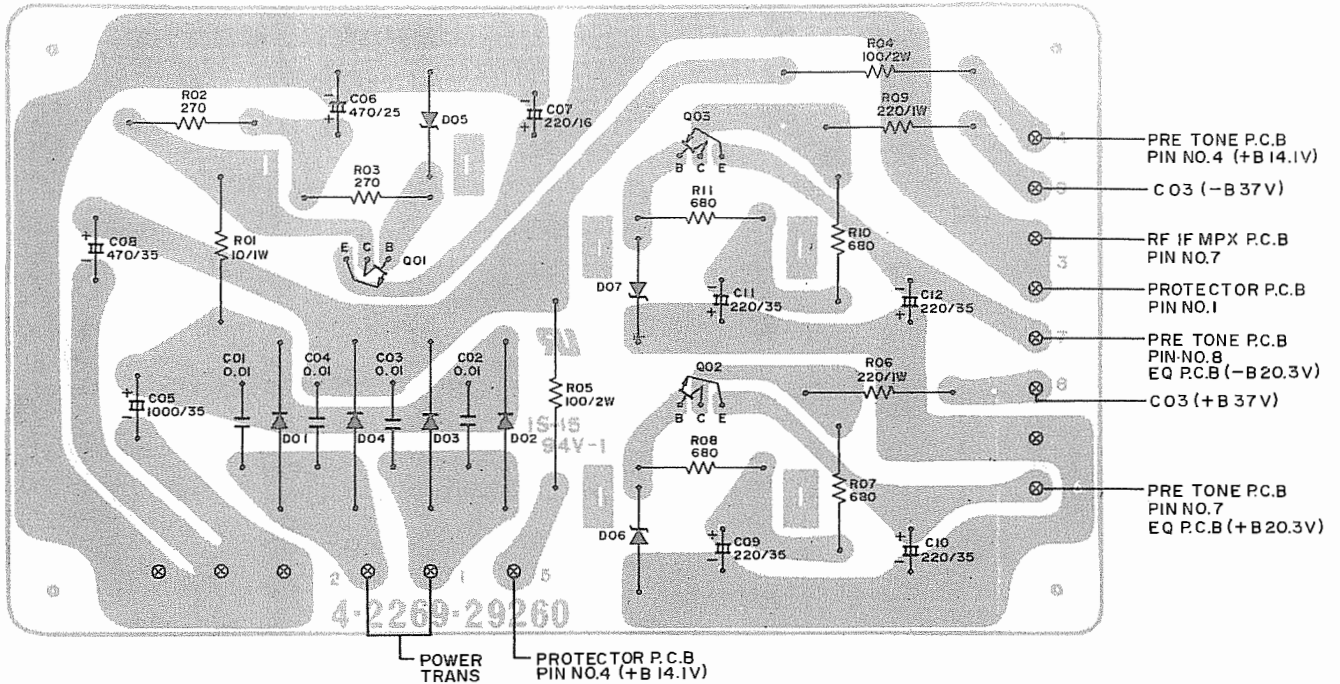

RS-1050

BOTTOM VIEW

POWER SUPPLY P.C.BOARD

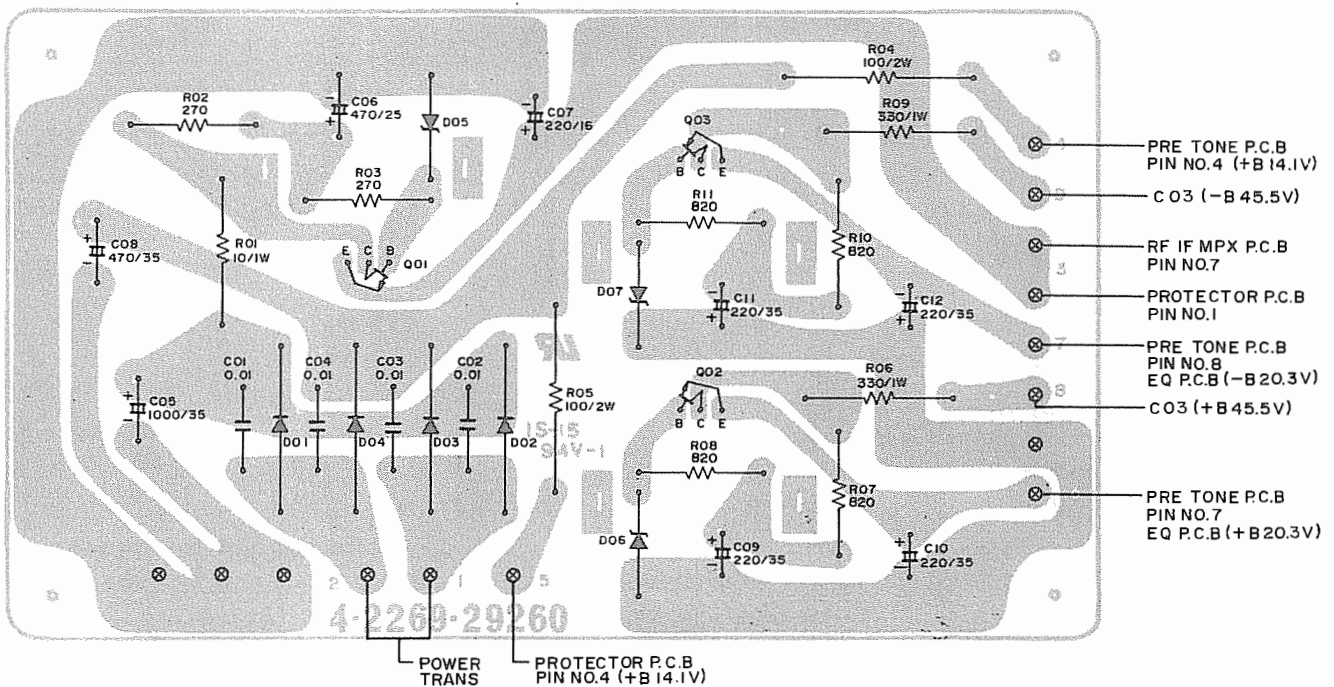

BOTTOM VIEW

# EQ P.C. BOARD

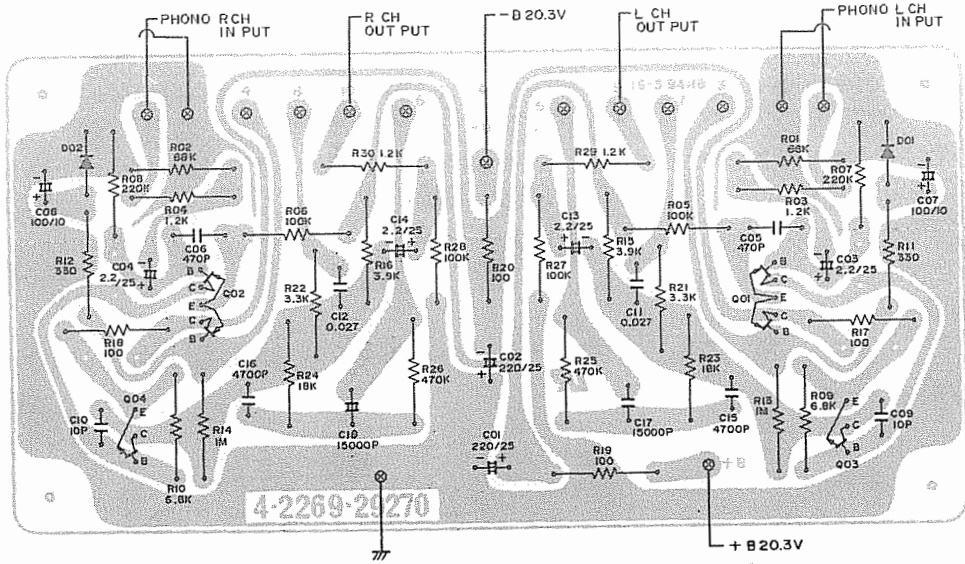

BOTTOM VIEW

# DIAL LAMP P.C. BOARD

RS-1040

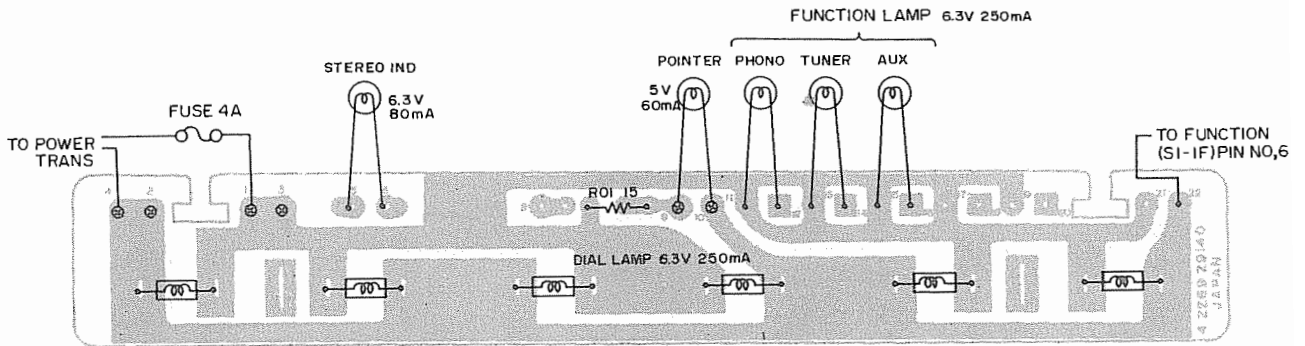

RS-1050

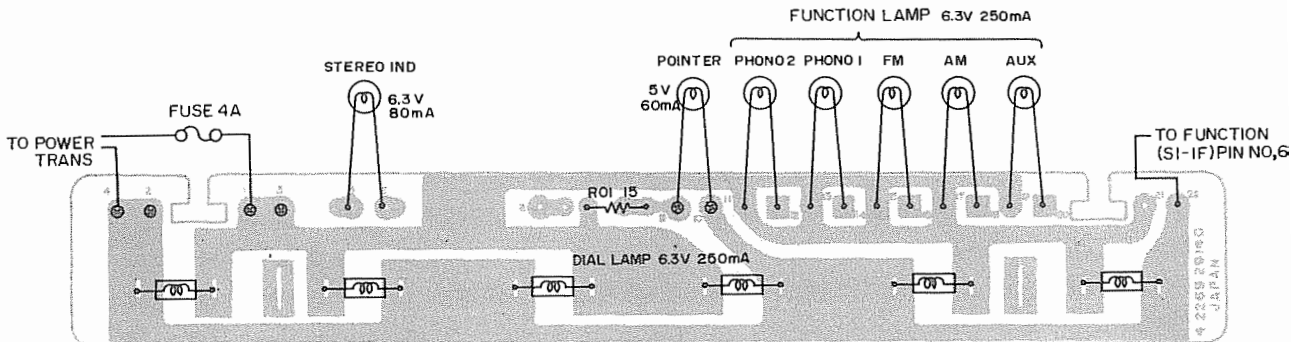

BOTTOM VIEW



RS-1040  
RS-1050

PROTECTOR P.C. BOARD

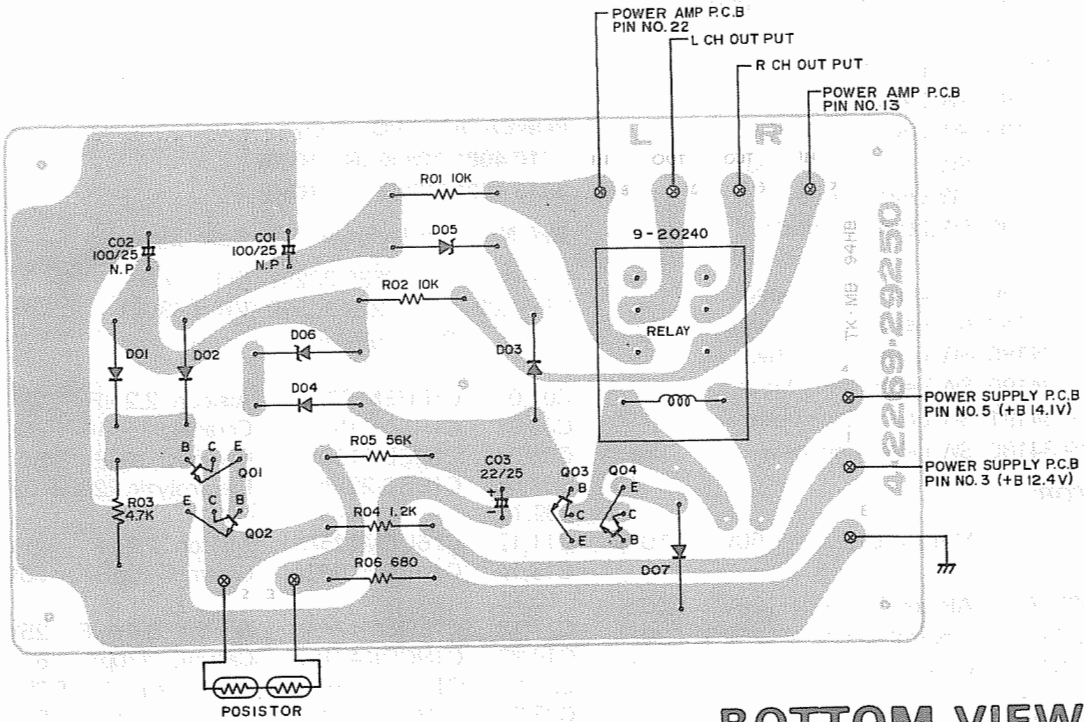

BOTTOM VIEW

EQ PCB Assy  
1310 4001 73100

Ref. No.	Part Number	Description
<b>CAPACITORS</b>		
C01,02	C1ERE-227A	Electrolytic 220 $\mu$ F 25V
C03,04	C1EUEM225A	Alsicon 2.2 $\mu$ F 25V $\pm$ 20 %
C05,06	C1HCDK471SL	Ceramic 470pF 50V $\pm$ 10 %
C07,08	C1ARE-107A	Electrolytic 100 $\mu$ F 10V
C09,10	C1HCSD100SL	Ceramic 10pF 50V $\pm$ 0.5 %
C11,12	C1HFRM273A	Mylar 0.027 $\mu$ F 50V $\pm$ 20 %
C13,14	C1EUEM225A	Alsicon 2.2 $\mu$ F 25V $\pm$ 20 %
C15,16	C1HSEJ472A	Styrol 4700pF 50V $\pm$ 5 %
C17,18	C1HSEJ153A	Styrol 15000pF 50V $\pm$ 5 %
<b>SEMICONDUCTORS</b>		
D01,02	2055 9040 44210	Diode DS-442
Q01,02	TMM-2SA798--F	TR 2SA798 F
Q03,04	2035 5151 57079	TR 2SC1570 LG

PROTECTOR PCB Assy  
1310 4001 72900

Ref. No.	Part Number	Description
	4 2329 20240	Relay
<b>CAPACITORS</b>		
C01,02	C1EAEN107A	Electrolytic 100 $\mu$ F 25V $\pm$ 30 %
C03	C1ERE-226A	Electrolytic 22 $\mu$ F 25V
<b>SEMICONDUCTORS</b>		
D01,02	2055 9040 44210	Diode DS-442
03,04		
D05,06	DNN-RD6.2E	Diode RD-6.2 E
D07	2025 2310 13020	Diode DS130 YD
Q01,02	2035 5100 53650	TR 2SC536 E
03		
Q04	2035 6701 17550	TR 2SC1175 E

# PARTS LIST

**PRE TONE PCB Assy**  
**1310 4001 73200 (RS-1040)**  
**1310 4001 74900 (RS-1050)**

Ref. No.	Part Number	Description
	4 2229 25480	VR B-100kx2 (RS-1040)
	4 2229 25390	VR B-100kx2 (RS-1050)
(RS-1040 )		
S03	4 2319 34180	SW Lever FM Muting
S04	4 2319 34180	SW Lever Low Filter
S05	4 2319 34180	SW Lever High Filter
S06	4 2319 34190	SW Lever Mono Mode
S07	4 2319 34170	SW Lever Turnover
S08	4 2319 34180	SW Lever Loudness
(RS-1050)		
S03	4 2319 34180	SW Lever FM Muting
S04	4 2319 34180	SW Lever Low Filter
S05	4 2319 34180	SW Lever High Filter
S06	4 2319 34190	SW Lever Mono Mode
S07	4 2319 34191	SW Lever Tone Controls
S08	4 2319 34180	SW Lever Loudness

## CAPACITORS

C03,04	C1HFAK153A	Mylar 0.015 $\mu$ F	50V	$\pm 10\%$
05,06				
C07,08	C1EUEM225A	Alsicon 2.2 $\mu$ F	25V	$\pm 20\%$
C09,10	C1EAEN226A	Electrolytic 22 $\mu$ F	25V	$\pm 30\%$
C11,12	C1HCDK180SL	Ceramic 18pF	50V	$\pm 10\%$
13,14				
C15,16	C1EUEM225A	Alsicon 2.2 $\mu$ F	25V	$\pm 20\%$
C17,18	C1EAEN106A	Electrolytic 10 $\mu$ F	25V	$\pm 30\%$
(RS-1040)				
C19,20	C1HFAJ333A	Mylar 0.033 $\mu$ F	50V	$\pm 5\%$
21,22				
23,24				
C27,28	C1HFAK102A	Mylar 0.001 $\mu$ F	50V	$\pm 10\%$
C29,30	C1HFRK224A	Mylar 0.22 $\mu$ F	50V	$\pm 10\%$
C31,32	C1HYDM681R	Titanium 680pF	50V	$\pm 20\%$
C33,34	C1ERE-227A	Electrolytic 220 $\mu$ F	25V	
C35	C1HYDZ473A	Ceramic 0.047 $\mu$ F	50V +80,-20 %	
(RS-1050)				
C19,20	C1HFRK183A	Mylar 0.018 $\mu$ F	50V	$\pm 10\%$
21,22				
C23,24	C1HFRK472A	Mylar 0.0047 $\mu$ F	50V	$\pm 10\%$
C27,28	C1HFRK332A	Mylar 0.0033 $\mu$ F	50V	$\pm 10\%$
C29,30	C1HFRK682A	Mylar 0.0068 $\mu$ F	50V	$\pm 10\%$
C31,32	C1HFRK224A	Mylar 0.22 $\mu$ F	50V	$\pm 10\%$
C33,34	C1HYDK681R	Ceramic 680pF	50V	$\pm 10\%$
C35,36	C1ERE-227A	Electrolytic 220 $\mu$ F	25V	
C37	C1HYDZ473A	Ceramic 0.047 $\mu$ F	50V +80,-20 %	

Ref. No. Part Number Description

## SEMICONDUCTORS

Q01,02	2035 5151 57079	TR 2SC1570 LG
05,06		
Q03,04	TMM-2SA798--F	TR 2SA798 F

**POWER AMP PCB Assy**  
**1310 4001 72800 (RS-1040)**  
**1310 4001 72801 (RS-1050)**

Ref. No. Part Number Description

L01,02	4 2539 20281	Coil 2 $\mu$ H
VR01,02	4 2229 25500	VR B-330x1

## CAPACITORS

C01,02	C1EUEM 225A	Alsicon 2.2 $\mu$ F	25V	$\pm 20\%$
C03,04	C1HCDK151SL	Ceramic 150pF	50V	$\pm 10\%$
C05,06	C1HCDD100SL	Ceramic 10pF	50V	$\pm 0.5\%$
C07,08	C1ERB-227A	Electrolytic 220 $\mu$ F	25V	
09,10				
C11,12	C1EUEM225A	Alsicon 2.2 $\mu$ F	25V	$\pm 20\%$
C13,14	C1HCDD100SL	Ceramic 10pF	50V	$\pm 0.5\%$
15,16				
C17,18	C1EUEM474A	Alsicon 0.47 $\mu$ F	25V	$\pm 20\%$
C19,20	C1HCDK471SL	Ceramic 470pF	50V	$\pm 10\%$
C21,22	C1ERB-106A	Electrolytic 10 $\mu$ F	25V	
C23,24	C1HCDK270SL	Ceramic 27pF	50V	$\pm 10\%$
25,26				
C27,28	C1HRB-227A	Electrolytic 220 $\mu$ F	50V	
29,30				
C31,32	C1HFRM153A	Mylar 0.015 $\mu$ F	50V	$\pm 20\%$
33,34				
C35,36	C1HFRM104A	Mylar 0.1 $\mu$ F	50V	$\pm 20\%$

## SEMICONDUCTORS

D01,02	DJJ-WZ-210	Diode WZ-210
03,04		
D05,06	2055 9040 44210	Diode DS-442
07,08		
09,10		
11,12		
13,14		
15,16		
Q01,02	TMM-2SA798--F	TR 2SA798 F
Q03,04	2035 5151 57079	TR 2SA1570 LG
Q05,06	TMM-2SA798--F	TR 2SA798 F
Q07,08	2035 6920 43840	TR 2SD438
Q09,10	2035 6930 56040	TR 2SB560 D
Q11,12	2035 6920 43840	TR 2SD438
Q13,14	2035 6701 17550	TR 2SC1175 E
Q15,16	2035 6800 65950	TR 2SA659 E
Q17,18	TMM-2SD358--D	TR 2SD358 D
Q19,20	TMM-2SB528--D	TR 2SB528 D

# POWER AMP P.C. BOA

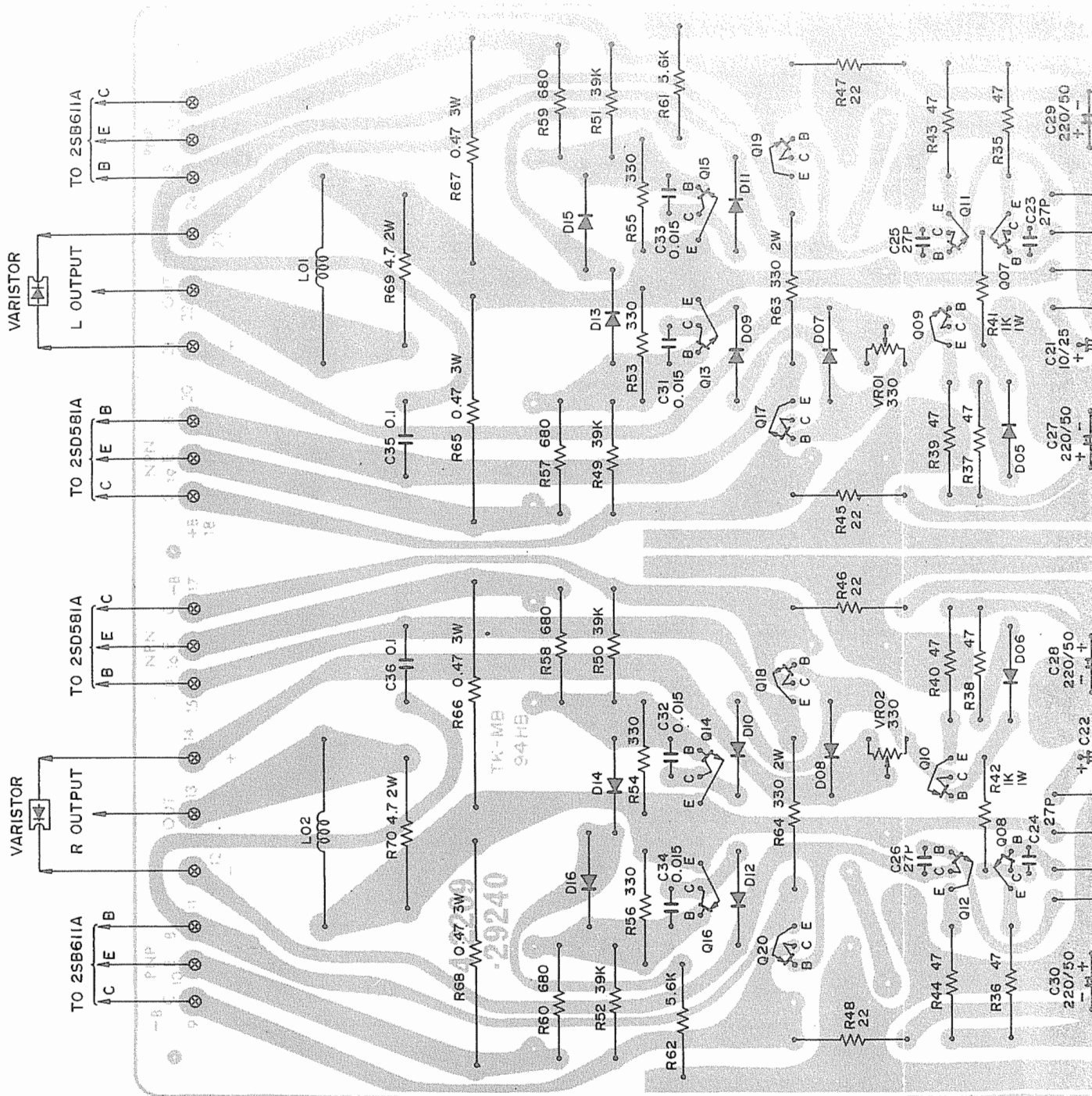

TRANSISTOR DC VOLTAGES

SYMBOL NO.	DEVICE	B	C	E	C	B	SYMBOL NO.	DEVICE	B	C	E
Q01,02	2SA798	0.023V	-19.5V	0.59V	-20.4V	0.02V	Q11,12	2SD438	-34.9V	-1.21V	
Q03,04	2SC1570	-19.5V	-0.04V	-20.1V			Q13,14	2SC1175	0.222V	0.95V	0.008V
Q05,06	2SA798	0.088V	-35.1V	0.688V	-35.1V	0.092V	Q15,16	2SA659	-0.2V	-0.008V	-0.94V
Q07,08	2SD438	-34.7V	-25.8V	-35.4V			Q17,18	2SD358	1.2V	37.0V	0.61V
Q09,10	2SB560	35.8V	1.2V	35.4V			Q19,20	2SB528	-1.21V	-37.0V	-0.6V

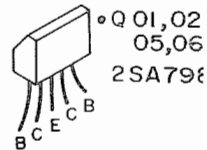

BOARD

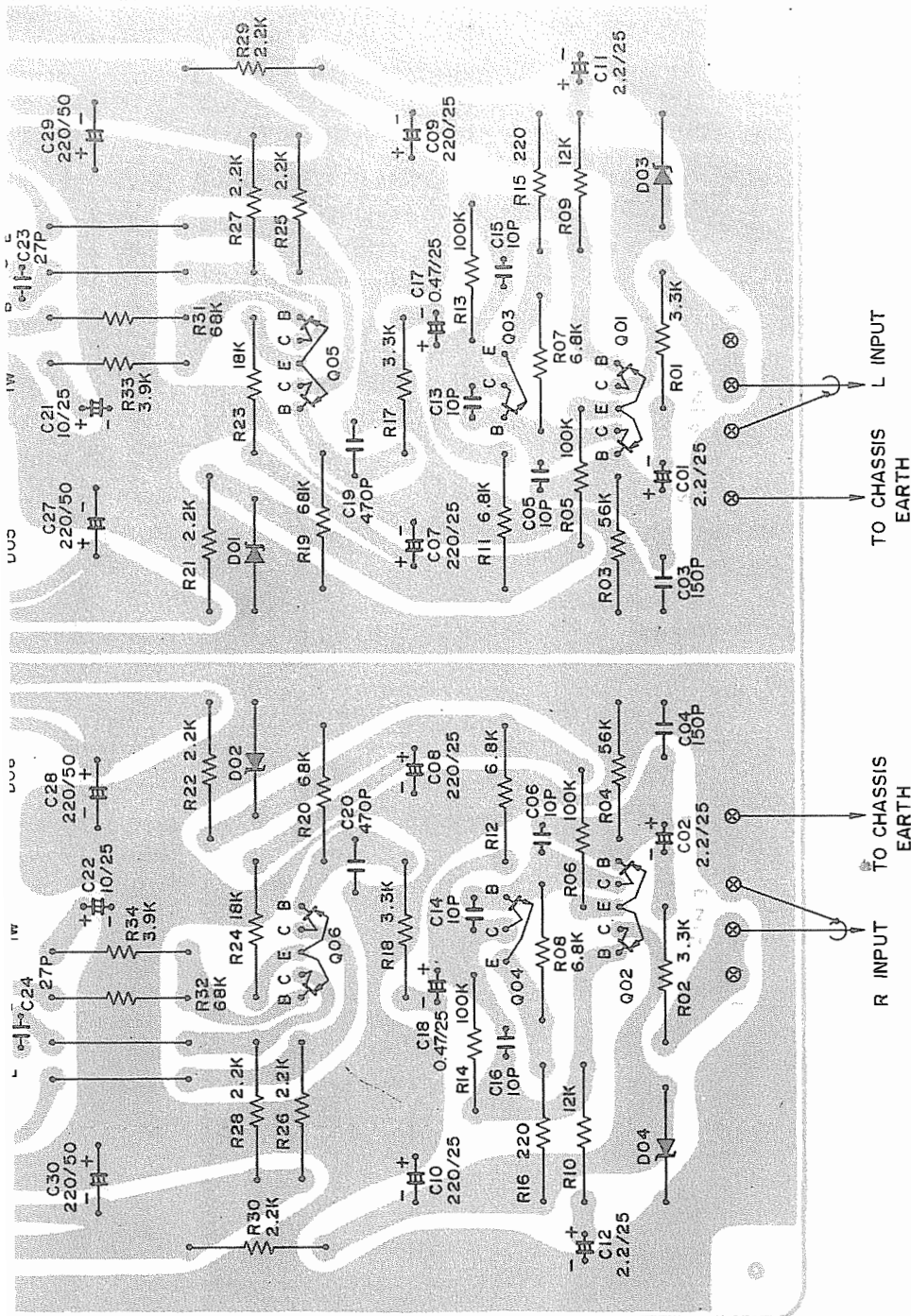

TRANSISTOR FRONT VIEW

Q 01, 02  
05, 06  
2SA798



• Q 03, 04  
2SC1570  
• Q 13, 14  
2SC1175  
• Q 15, 16  
2SA659



• Q 07, 08  
11, 12  
2SD438  
• Q 09, 10  
2SB560

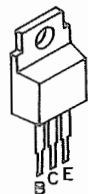

• Q 17, 18  
2SD358  
• Q 19, 20  
2SB528

BOTTOM VIEW

DIODE FRONT VIEW

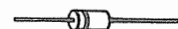

• D01~04 WZ110  
• D05~16 DS-442

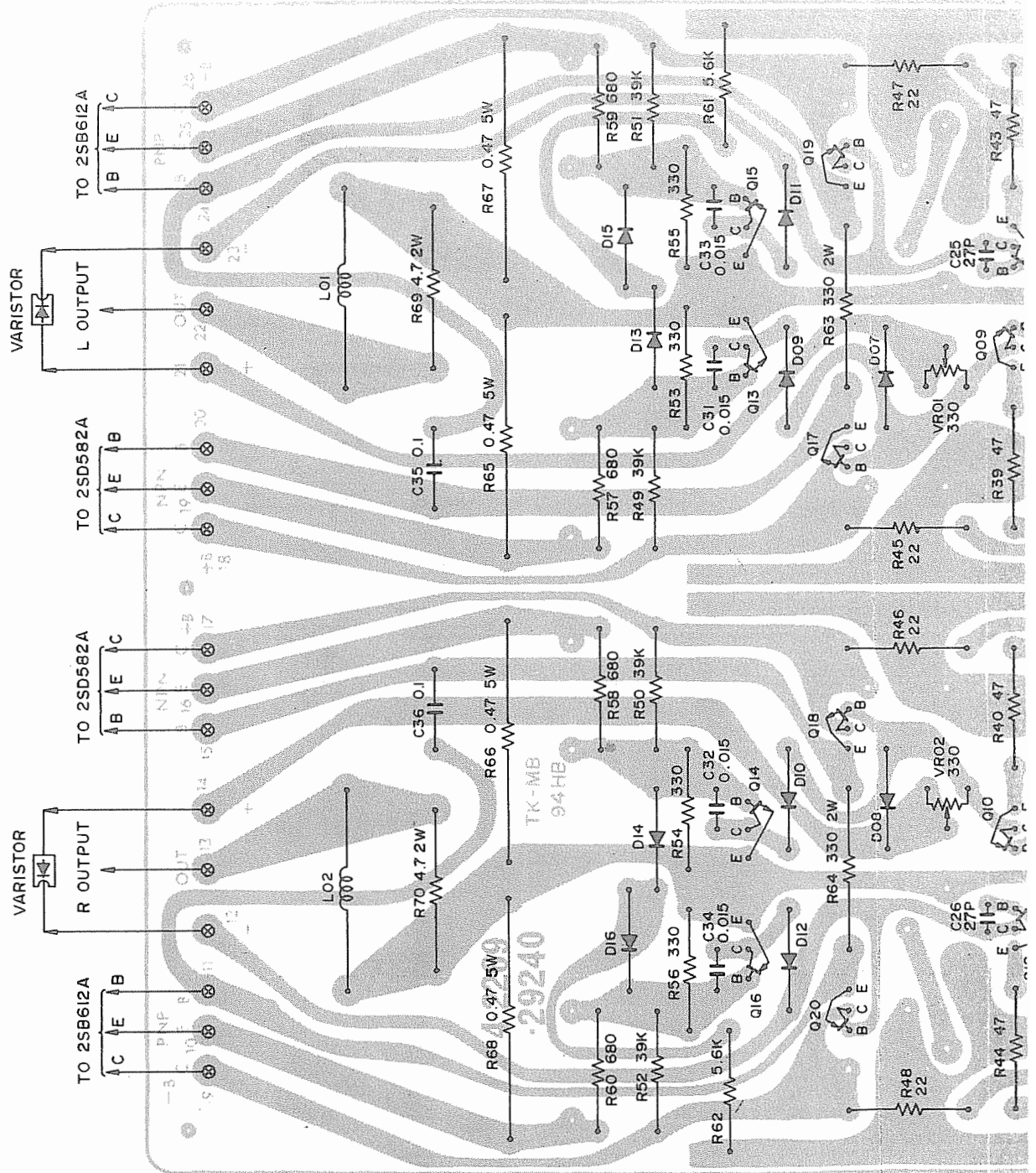

TRANSISTOR DC VOLTAGES											
SYMBOL NO.	DEVICE	B	C	E	C	B	SYMBOL NO.	DEVICE	B	C	E
Q01,02	2SA798	0.012V	-20V	0.59V	-20.9V	0.01V	Q11,12	2SD438	-42.5V	-1.21V	-43.3V
Q03,04	2SC1570	-20V	-0.03V	-20.6V			Q13,14	2SC1175	0.222V	1.08V	0.008V
Q05,06	2SA798	0.088V	-42.5V	0.688V	-42.5V	0.092V	Q15,16	2SA659	-0.208V	-0.008V	-0.94V
Q07,08	2SD438	-42.5V	-25.8V	-42.6V			Q17,18	2SD358	1.18V	45.5V	0.613V
Q09,10	2SB560	42.8V	1.18V	43.3V			Q19,20	2SB528	-1.21V	-45.5V	-0.6V



# AMP P.C. BOARD

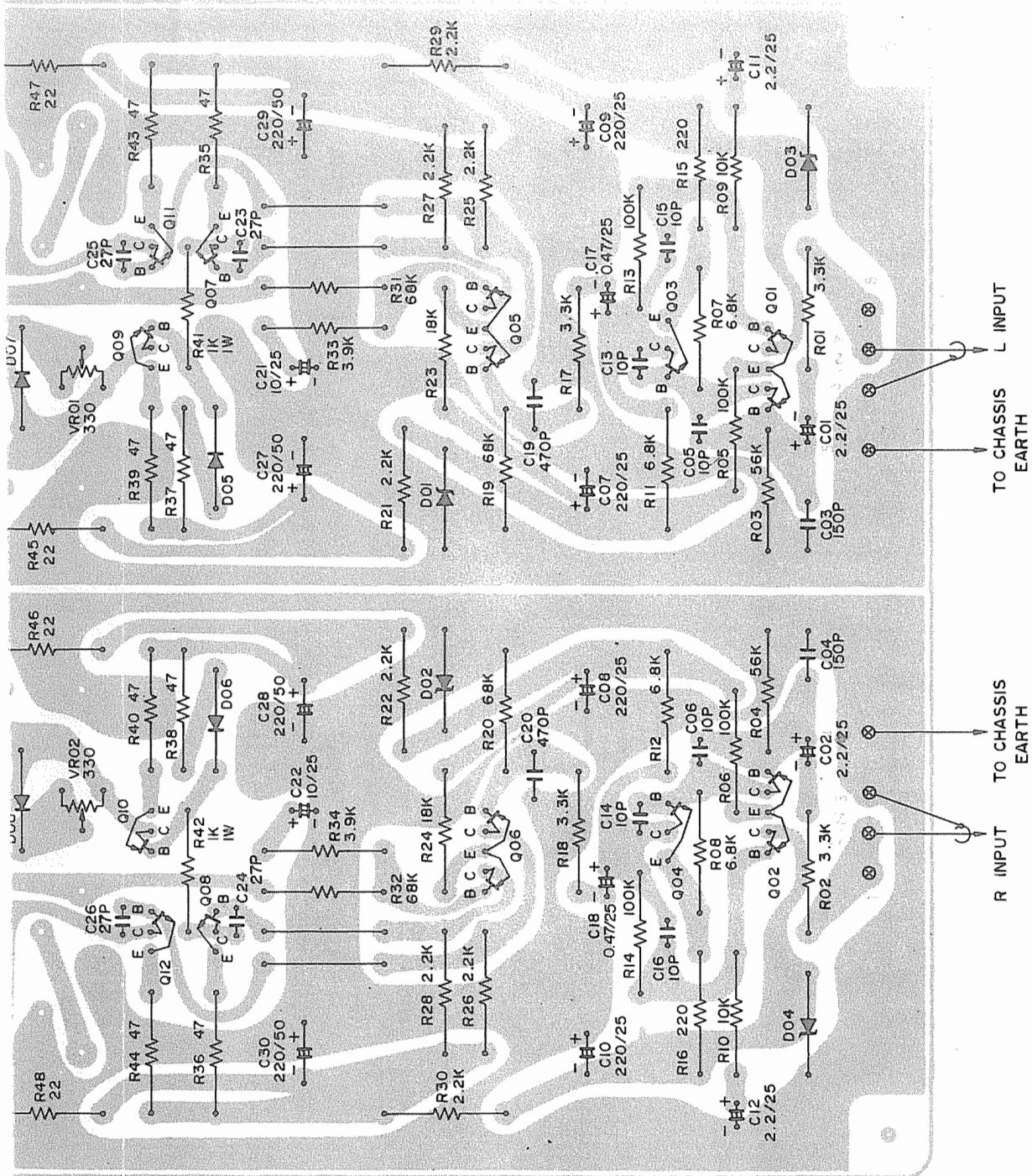

TRANSISTOR FRONT VIEW

E
-43.3V
0.008V
-0.94V
0.613V
-0.6V

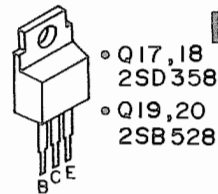
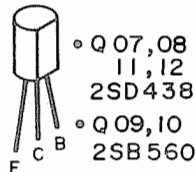
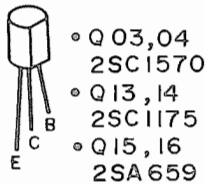
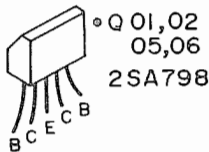

## BOTTOM VIEW

DIODE FRONT VIEW

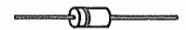

- D01~04 WZ 210
- D05~16 DS-442



# PARTS LIST

AM FM RF/IF MPX PCB Assy  
1310 4001 72700

Ref. No.	Part Number	Description
L01	4 2539 20370	Coil 10 $\mu$ H $\pm 10\%$
L02	4 2539 20380	Coil 18 $\mu$ H $\pm 5\%$
L03	4 2539 20310	Coil 1 $\mu$ H $\pm 5\%$
L04	4 2539 20170	Choke Coil 1 mH
T01	4 2569 21320	IF Trans FM
T02	4 2569 21310	IF Trans AM
T03	4 2589 20880	OSC Coil AM
VR01	4 2229 25100	Semi-Fixed VR 47k-B
VR02	4 2229 22910	VR 1k-B
VR03	4 2229 23880	VR 4.7k-B
VR04	4 2229 25100	Semi-Fixed VR 47k-B
	4 2279 20320	Low Pass Filter
	4 2359 23120	Socket 16P
CF01,02	4 2279 20310	Ceramic Filter

### CAPACITORS

C01	C1HYSZ473A	Ceramic 0.047 $\mu$ F 50V +80,-20%
C02	C1HYSZ102A	Ceramic 0.001 $\mu$ F 50V +80,-20%
C03	C1HYSZ473A	Ceramic 0.047 $\mu$ F 50V +80,-20%
C04	C1CRB-107A	Electrolytic 100 $\mu$ F 16V
C05,06 07,08 09,10	C1HYDZ473A	Ceramic 0.047 $\mu$ F 50V +80,-20%
C11	C1CUEX474A	Alsicon 0.47 $\mu$ F 16V +40,-20%
C12,13	C1EUEM105A	Alsicon 1 $\mu$ F 25V $\pm 20\%$
C14	C1HCDK331SL	Ceramic 330pF 50V $\pm 10\%$
C15	C1CTRM226A	Tantalum 22 $\mu$ F 16V $\pm 20\%$
C16,17 C18	C1HYDZ473A	Ceramic 0.047 $\mu$ F 50V +80,-20%
C19	C1HSEJ152A	Styrol 1500pF 50V $\pm 5\%$
C20	C1CUEX474A	Alsicon 0.47 $\mu$ F 16V +40,-20%
C21,22	C1EUEM224A	Alsicon 0.22 $\mu$ F 25V $\pm 20\%$
C23	C1HFRM473A	Mylar 0.047 $\mu$ F 50V $\pm 20\%$
C24	C1CRB-476A	Electrolytic 47 $\mu$ F 16V
C25,26	C1CUEX475A	Alsicon 4.7 $\mu$ F 16V +40,-20%
C27	C1ERB-107A	Electrolytic 100 $\mu$ F 25V
C28	C1HCSK470SL	Ceramic 47pF 50V $\pm 10\%$
C29	C1CRB-475A	Electrolytic 4.7 $\mu$ F 16V
C30	C1HCDK221SL	Ceramic 220pF 50V $\pm 10\%$
C31,32 33	C1HYDZ473A	Ceramic 0.047 $\mu$ F 50V +80,-20%
C34	C1CRB-106A	Electrolytic 10 $\mu$ F 16V
C35,36	C1HYDZ473A	Ceramic 0.047 $\mu$ F 50V +80,-20%
C37	C1HFRM103A	Mylar 0.01 $\mu$ F 50V $\pm 20\%$
C38	C1HSEJ431A	Styrol 430pF 50V $\pm 5\%$
C39	C1CRB-476A	Electrolytic 47 $\mu$ F 16V
C40	C1HCDJ120SL	Ceramic 12pF 50V
C41	C1CRB-226A	Electrolytic 22 $\mu$ F 16V
C42,43	C1HYDZ103A	Ceramic 0.01 $\mu$ F 50V +80,-20%
C44	C1HFRM103A	Mylar 0.01 $\mu$ F 50V $\pm 20\%$
C45	C1HFRM333A	Mylar 0.033 $\mu$ F 50V $\pm 20\%$
C46	C1EUEM225A	Alsicon 2.2 $\mu$ F 25V $\pm 20\%$
C47	C1CUEX475A	Alsicon 4.7 $\mu$ F 16V +40,-20%
C48	C1HYDZ473A	Ceramic 0.047 $\mu$ F 50V +80,-20%

Ref. No.	Parts No.	Description
<b>SEMICONDUCTORS</b>		
D01,02 03,04 05,06 07	2055 9040 44210	Diode DS-442
IC01	2065 0131 22210	IC LA1222
IC02	2065 0151 23010	IC LA 1230
IC03	2065 0743 35019	IC LA-3350SS
IC04	IKK-HA1138	IC HA1138
Q01	2035 5100 53640	TR 2SC536 D or E
Q02	2035 6800 65940	TR 2SA659 D or E
Q03,04 05	2035 5100 53640	TR 2SC536 D or E

### RESISTORS

R01	R2EDSJ681A	Carbon 680	1/4W $\pm 5\%$
R02	R2EDSJ102A	Carbon 1k	1/4W $\pm 5\%$
R03	R2EDSJ331A	Carbon 330	1/4W $\pm 5\%$
R04	R2EDSJ101A	Carbon 100	1/4W $\pm 5\%$
R05,06	R2EDSJ331A	Carbon 330	1/4W $\pm 5\%$
R07	R2EDSJ564A	Carbon 560k	1/4W $\pm 5\%$
R08	R2EDSJ563A	Carbon 56k	1/4W $\pm 5\%$
R09	R2EDSJ104A	Carbon 100k	1/4W $\pm 5\%$
R10	R2EDUJ683A	Carbon 68k	1/4W $\pm 5\%$
R11	R2EDSJ473A	Carbon 47k	1/4W $\pm 5\%$
R12	R2EDSJ222A	Carbon 2.2k	1/4W $\pm 5\%$
R13	R2EDSJ101A	Carbon 100	1/4W $\pm 5\%$
R14	R2EDSJ562A	Carbon 5.6k	1/4W $\pm 5\%$
R15	R2EDSJ822A	Carbon 8.2k	1/4W $\pm 5\%$
R16	R2EDSJ102A	Carbon 1k	1/4W $\pm 5\%$
R17	R2EDSJ123A	Carbon 12k	1/4W $\pm 5\%$
R18	R2EDSJ122A	Carbon 1.2k	1/4W $\pm 5\%$
R19	R2EDSJ184A	Carbon 180k	1/4W $\pm 5\%$
R20	R2EDSJ124A	Carbon 120k	1/4W $\pm 5\%$
R21,22	R2EDSJ222A	Carbon 2.2k	1/4W $\pm 5\%$
R23	R2EDSJ331A	Carbon 330	1/4W $\pm 5\%$
R24	R2EDSJ822A	Carbon 8.2k	1/4W $\pm 5\%$
R25,26 27	R2EDSJ332A	Carbon 3.3k	1/4W $\pm 5\%$
R28	R2EDSJ101A	Carbon 100	1/4W $\pm 5\%$
R29	R3AXBJ680A	Oxide Metal Film 68 1W	$\pm 5\%$
R30	R2EDSJ332A	Carbon 3.3k	1/4W $\pm 5\%$
R31	R2EDSJ102A	Carbon 1k	1/4W $\pm 5\%$
R32	R2EDSJ332A	Carbon 3.3k	1/4W $\pm 5\%$
R33	R2EDSJ102A	Carbon 1k	1/4W $\pm 5\%$
R34,35	R2EDSJ103A	Carbon 10k	1/4W $\pm 5\%$
R36	R2EDSJ101A	Carbon 100	1/4W $\pm 5\%$
R37	R2EDSJ222A	Carbon 2.2k	1/4W $\pm 5\%$
R38	R2EDSJ332A	Carbon 3.3k	1/4W $\pm 5\%$
R39,40	R2EDSJ470A	Carbon 47	1/4W $\pm 5\%$
R41	R2EDSJ151A	Carbon 150	1/4W $\pm 5\%$
R42	R2EDSJ4R7A	Carbon 4.7	1/4W $\pm 5\%$
R43	R2EDSJ273A	Carbon 27k	1/4W $\pm 5\%$
R44	R2EDSJ681A	Carbon 680	1/4W $\pm 5\%$
R45	R2EDSJ272A	Carbon 2.7k	1/4W $\pm 5\%$
R46	R2EDSJ222A	Carbon 2.2k	1/4W $\pm 5\%$
R47	R2EDSJ101A	Carbon 100	1/4W $\pm 5\%$
R48	R2EDSJ563A	Carbon 56k	1/4W $\pm 5\%$
R49	R2EDUJ472A	Carbon 4.7k	1/4W $\pm 5\%$
R50	R2EDUJ103A	Carbon 10k	1/4W $\pm 5\%$
R51	R2EDSJ103A	Carbon 10k	1/4W $\pm 5\%$
R52	R2EDSJ472A	Carbon 4.7k	1/4W $\pm 5\%$

### TRANSISTOR DC VOLTAGES

SYMBOL NO.	DEVICE	B	C	E
Q01	2SC536	1.09V	0.56V	0.56V
Q02	2SA659	5.33V	5.36V	6.12V
Q03,04	2SC536	0V	0V	0V
Q05	2SC536	0.03V	3.78V	0V

## ELECTRICAL PART LIST

Part Number	Description	Ref. No.	Part Number	Description
4 1259 20390	Front End (Component parts used in Front End are not serviceable and available.)	C08	C1CRE-227A	Cap. Electrolytic 220 $\mu$ F 16V
		C09	C1EUEM475A	Cap. Alsicon 4.7 $\mu$ F 25V $\pm$ 20 %
		C10	C1HYDZ473A	Cap. Ceramic 0.047 $\mu$ F 50V +80
		C11	C1HFRM104A	Cap. Mylar 0.1 $\mu$ F 50V $\pm$ 20 %
4 2229 25490	VR A-50k, MN-250k	67	DDD-S5VB20	Diode S5VB20 (Power Supply)
4 2349 20730	Fuse 4A AC (RS-1040)	67-1	C2HYDP103A	Cap. Ceramic 0.01 $\mu$ F 500V +100, -0 %
4 2349 20910	Fuse 5A AC (RS-1050)	(C04,05		
4 2349 21300	Fuse 1A	06,07)		
4 2349 21310	Fuse 4A (RS-1040)	68	DAA-STV-3H-W	Diode STV-3H (Idling Bias)
4 2349 21380	Fuse 5A (RS-1050)	69	TKK-2SD581A-B	2SD581A-B or C (RS-1040)
4 2359 20161	Holder Lamp (RS-1040)	(Q01,02)	TKK-2SD582A-B	2SD582A-B or C (RS-1050)
4 2359 20160	Holder Lamp (RS-1050)	70	TKK-2SB611A-B	2SB611A-B or C (RS-1040)
4 2359 21110	Fuse Holder	(Q03,04)	TKK-2SB612A-B	2SB612A-B or C (RS-1050)
4 2359 21960	Socket	R03,04	R3DXPK471A	Resistor Oxide Metal Film 470 ohm 2W $\pm$ 10 %
4 2359 22130	RCA Pin Jack 2P			
4 2359 22440	Socket Transistor	R05,06	R2HXP151A	Resistor Oxide Metal Film 150 ohm 1/2W $\pm$ 10 %
4 2359 22710	Socket 4P			
4 2359 22730	Socket 1P	R07,08	R2HCPK185A	Resistor Solid 1.8M 1/2W $\pm$ 10 %
4 2369 20561	Plug 1P	R09,10	R3DXPK471A	Resistor Oxide Metal Film 470 ohm 2W $\pm$ 10 %
4 2369 21220	Short Plug			
4 2379 21460	Terminal, Antenna Connector	R11,12	R2HXP151A	Resistor Oxide Metal Film 150 ohm 1/2W $\pm$ 10 %
4 2379 21570	Terminal, Speakers Connector			
4 2439 20720	Power Cord	R13,14	R3DXPK100A	Resistor Oxide Metal Film 10 ohm 2W $\pm$ 10 %
4 2519 23751	Power Trans (RS-1040)			
4 2519 23761	Power Trans (RS-1050)	71(S-01)	4 2319 34150	Switch Rotary Function
4 2539 20430	Peaking Coil 10 $\mu$ H (L01)	72(S-02)	4 2319 34130	Switch Rotary Tape Monitor
4 2579 25040	AM Antenna	73(S-09)	4 2319 34140	Switch Rotary Speaker
4 2599 20300	Balun	74(S-10)	4 2319 34160	Switch Lever Power
4 5119 20670	Meter, Signal Strength	74-1	C2JNRM103C	Capacitor Polypropilene 0.01 $\mu$ F 630V $\pm$ 20 %
4 5119 20680	Meter, Center of Channel	(C01)		
4 6129 20280	Pilot Lamp 6.3V 250mA	75 *	1310 4001 72700	AM, FM RF/IF MPX PC Assy
4 6129 20592	Small Lamp Indicator 5V 60mA	76 *	1310 4001 72800	Power AMP PC Assy (RS-1040)
HII-PTH487A-BE	Posistor Protector	76 *	1310 4001 72801	Power AMP PC Assy (RS-1050)
R2HCPK222A	Resistor Solid 2.2k ohm 1/2W $\pm$ 10 %	77 *	1310 4001 72900	Protector PC Assy
4 2239 20990	Capacitor Electrolytic 10000 $\mu$ F 50V (RS-1040)	78 *	1310 4001 73000	Power Supply PC Assy (RS-1040)
		78 *	1310 4001 73001	Power Supply PC Assy (RS-1050)
4 2239 21000	Capacitor Electrolytic 15000 $\mu$ F 50V (RS-1050)	79 *	1310 4001 73100	EQ PC Assy
		80 *	1310 4001 73200	PRE Tone PC Assy (RS-1040)
		80 *	1310 4001 74900	PRE Tone PC Assy (RS-1050)
		81 *	1310 4001 72162	Dial Lamp PC Assy (RS-1040)
		81 *	1310 4001 72163	Dial Lamp PC Assy (RS-1050)

NOTE: \* Asterisk indicates not a service part

### POWER SUPPLY PCB Assy 1310 4001 73001 (RS-1050)

Ref. No.	Part Number	Description
<b>CAPACITORS</b>		
C01,02 03,04	C2HYDP103A	Ceramic 0.01 $\mu$ F 500V +100,-0 %
C05	C1VRE-108A	Electrolytic 1000 $\mu$ F 35V
C06	C1ERE-477A	Electrolytic 470 $\mu$ F 25V
C07	C1CRE-227A	Electrolytic 220 $\mu$ F 16V
C08	C1VRE-477A	Electrolytic 470 $\mu$ F 35V
C09,10 11,12	C1VRE-227A	Electrolytic 220 $\mu$ F 35V

### SEMICONDUCTORS

D01,02 03,04	2025 2310 13020	Diode DS130YD
D05	DJJ-WZ-130	Diode WZ-130
D06,07	DJJ-WZ-210	Diode WZ-210
Q01,02	2035 8220 33050	TR 2SD330E
Q03	2035 6460 51440	TR 2SB514 D

### POWER SUPPLY PCB Assy 1310 4001 73000 (RS-1040)

Ref. No.	Part Number	Description
<b>CAPACITORS</b>		
C01,02 03,04	C2HYDP103A	Ceramic 0.01 $\mu$ F 500V +100,-0 %
C05	C1VRE-108A	Electrolytic 1000 $\mu$ F 35V
C06	C1ERE-477A	Electrolytic 470 $\mu$ F 25V
C07	C1CRE-227A	Electrolytic 220 $\mu$ F 16V
C08	C1VRE-477A	Electrolytic 470 $\mu$ F 35V
C09,10 11,12	C1VRE-227A	Electrolytic 220 $\mu$ F 35V

### SEMICONDUCTORS

D01,02 03,04	2025 2310 13020	Diode DS130YD
D05	DJJ-WZ-130	Diode WZ-130
D06,07	DJJ-WZ-210	Diode WZ-210
Q01,02	2035 8220 33050	TR 2SD330 E
Q03	2035 6460 51440	TR 2SB514 D

# SCHEMATIC DIAGR

901, 03 ~ 05 25C536 002 25A559 001 ~ 07 D5442

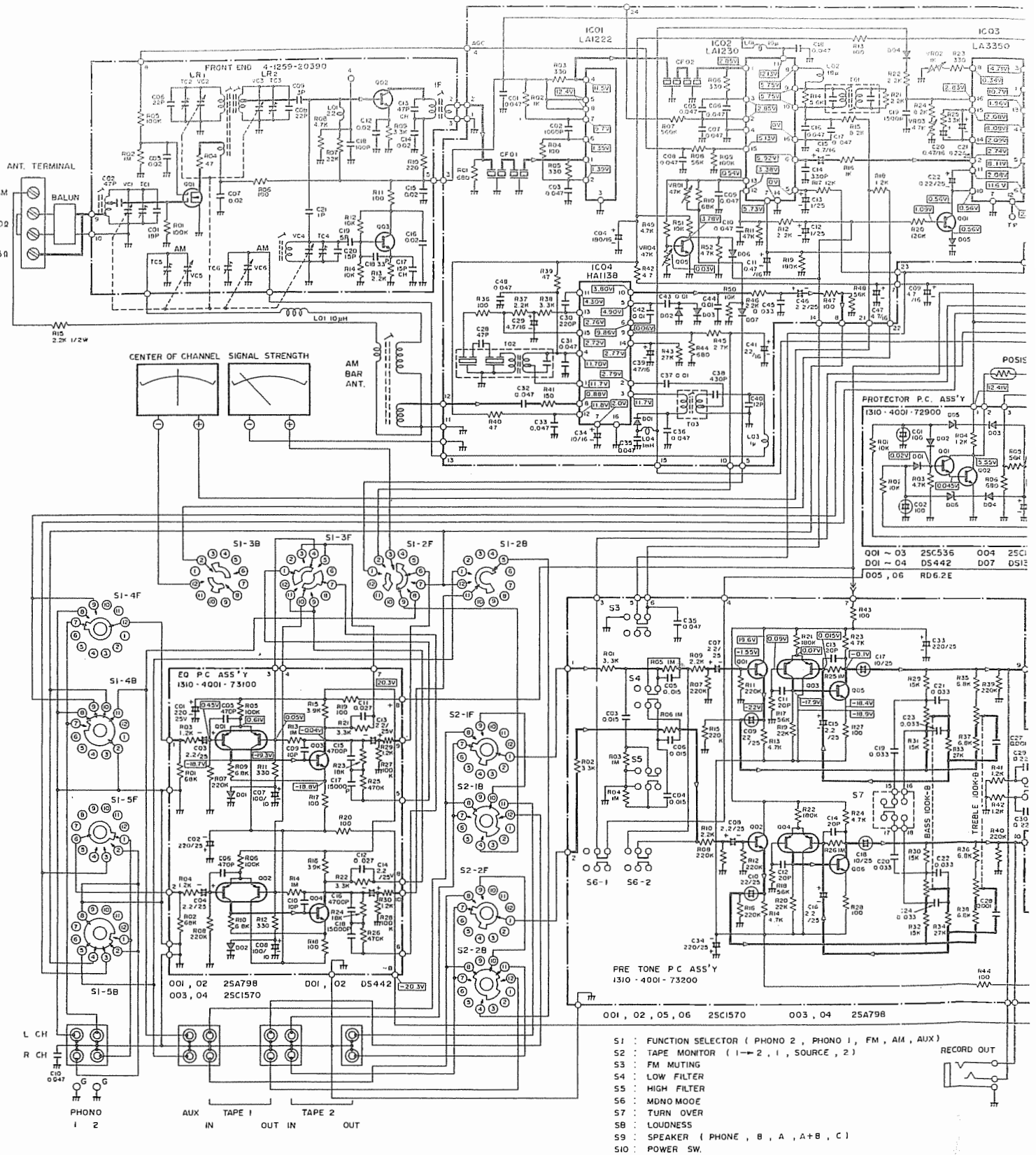

AGRAM

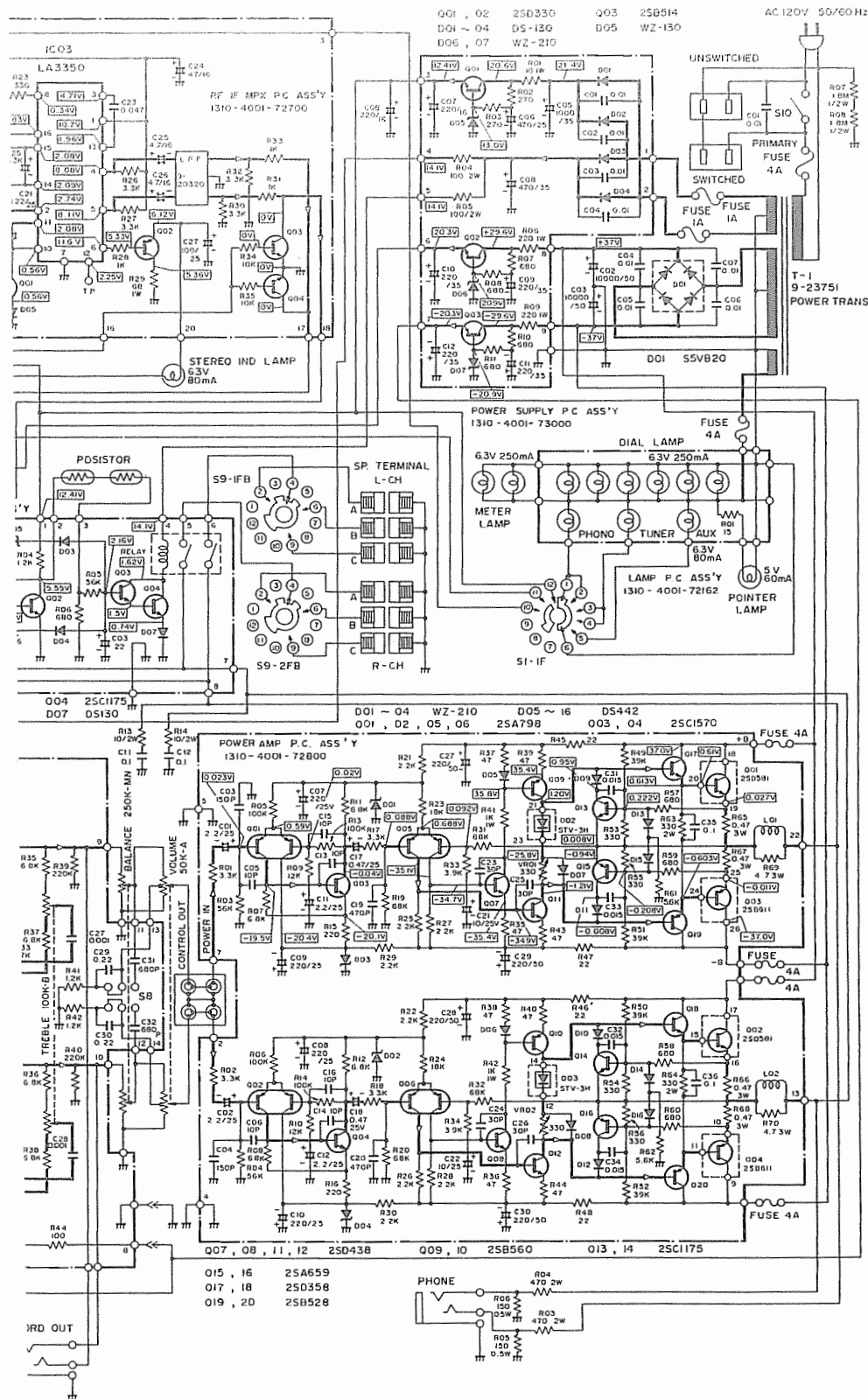

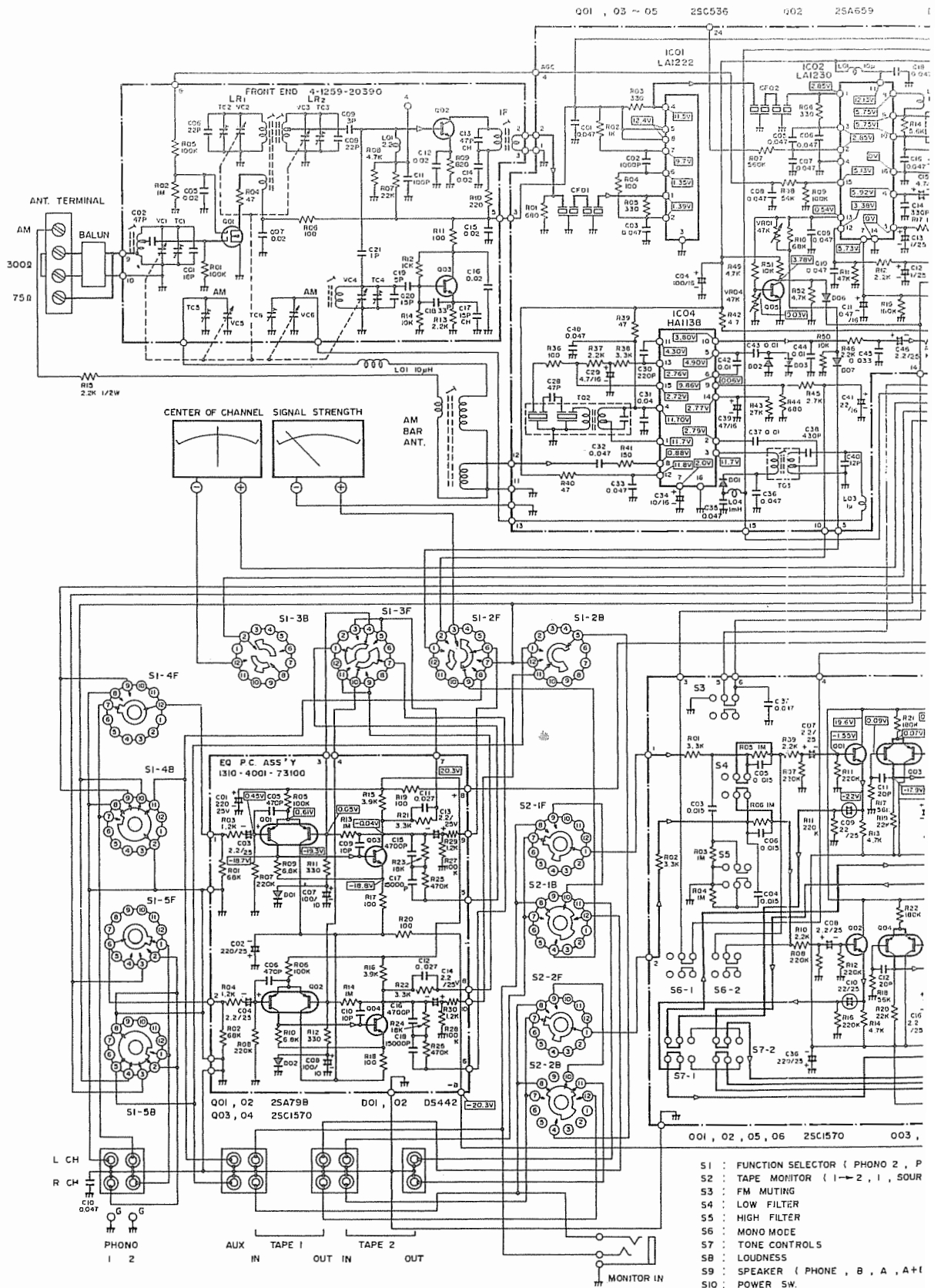

# EMATIC DIAGRAM

J02 25A659

D01 ~ 07

DS442

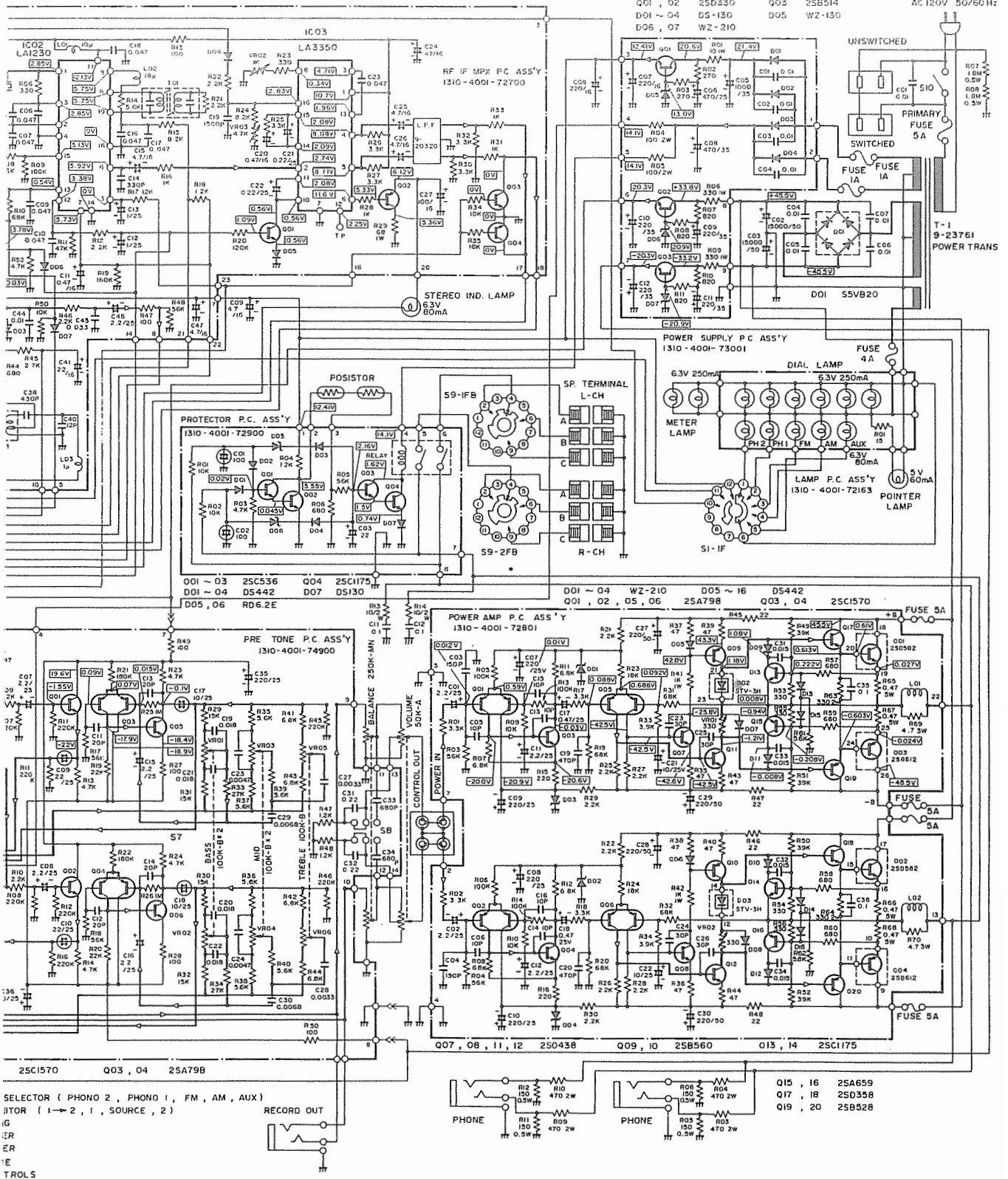

SELECTOR ( PHONO 2, PHONO 1, FM, AM, AUX )  
 ITOR ( 1 → 2, 1, SOURCE, 2 )

IG  
 IR  
 ER  
 E  
 TROLS

( PHONE, B, A, A+B, C )

W.

Q01, Q2 25D330 Q03 25B514 AC 120V 50/60Hz  
 D01 ~ 04 DS-130 D05 WZ-130  
 D06, 07 WZ-210

001 ~ 03 25C536 Q04 25C1175  
 D01 ~ 04 DS442 D07 DS130  
 D05, 06 RD6.2E

001 ~ 04 WZ-210 D05 ~ 16 DS442  
 Q01, 02, 05, 06 25A798 Q03, 04 25C1570

Q07, 08, 11, 12 25O438 Q09, 10 25B560 Q13, 14 25C1175

Q15, 16 25A659  
 Q17, 18 25O358  
 Q19, 20 25B528